

PCA

Light Duty Portable Parts Conveyor



The Model "PCA" Conveyor is easily positioned in or under punch presses, plastic injection molding machines, extruding equipment, and other machinery, where small steel or aluminum stampings, plastic parts, etc., must be quickly conveyed to hoppers or drums to keep production on the move.

- 6 Belt Widths
- Reversible
- Overhead Drive
- One Piece Troughed Bed
- Adjustable PCAS Type Floor Supports Availat

SIZE TO ORDER Overall Length "A"	Belt Width Bed Width "B"	4"	6"	8"	10"	12"	18"
		4 1/2"	6 1/2"	8 1/2"	10 1/2"	12 1/2"	18 1/2"
		9 1/8"	11 1/8"	13 1/8"	15 1/8"	17 1/8"	23 1/8"
4'	Weights (Lbs.)	96	107	116	125	134	162
5'		100	114	124	128	146	178
6'		106	121	133	145	158	196
8'		116	139	150	165	181	228
10'		126	146	166	186	205	262

All weights in catalog are conveyor weights only. Accessories, crating, etc., are not included.

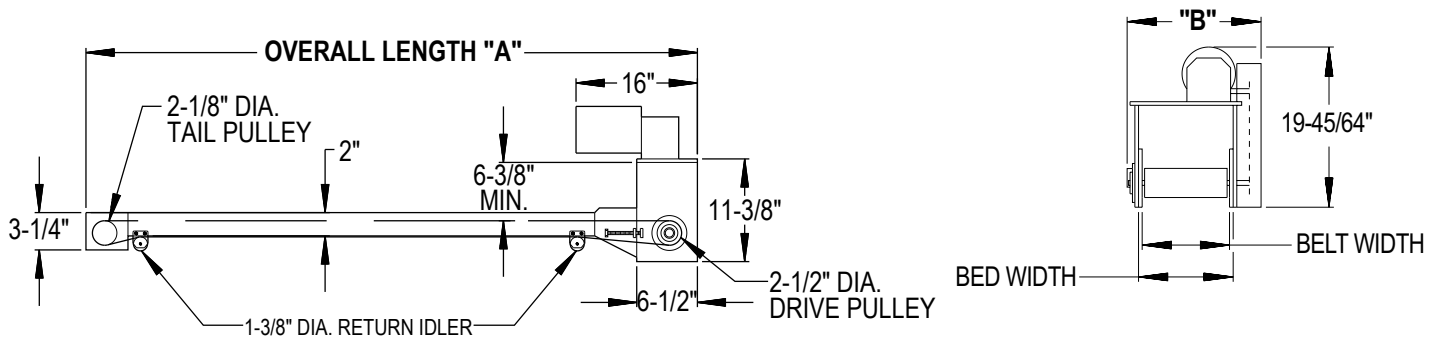

• STANDARD SPECIFICATIONS

OVERHEAD END DRIVE—Located on discharge end of conveyor. Chain guard located on left hand side.

BELT—Black Ultimate 140 SD. Clipper lacing.

BED—12 ga. steel formed troughed bed section with 1 in. high vertical sides.

DRIVE PULLEY—2 1/2 in. dia. with 1 in. dia. shaft, crowned and fully lagged.

TAIL PULLEY—2 1/2 in. dia. with 7/16 in. dia. threaded shaft. Pre-lubricated ball bearings.

RETURN IDLER—Adjustable 1 3/8 in. dia. pre-lubricated ball bearings.

TAKE-UP—Screw take-ups are provided at drive pulley to insure proper belt tension.

BEARINGS—Sealed, pre-lubricated ball bearings on drive pulley.

SPEED REDUCTION—Sealed worm gear "C" face speed reducer. No. 40 roller chain to drive pulley.

MOTOR—1/2 HP—230/460V—3 Ph. 60 Hz. Totally Enclosed Fan Cooled "C" face.

BELT SPEED—Constant 65 FPM.

CAPACITY—Maximum load per linear foot of conveyor 10 lbs.

• OPTIONAL EQUIPMENT

FLOOR SUPPORTS—PCAS Type floor supports are available with a wide range of adjustment. Specify top of belt or roller elevation. One support required at every bed joint and ends of conveyor. Holes in feet for lagging to floor. Knee braces recommended above PCAS-6 support.

BELT—White Polymate 100 RPM COS.

BELT SPEED—Other constant speeds 11 to 82 FPM, specify.

BED—Higher than 1 in. high vertical sides.

UNDERSIDE DRIVE—Gearhead motor mounted underneath bed section.

MOTORS—Energy efficient, single phase, other characteristics. 1/2 HP maximum.

ELECTRICAL CONTROLS—Manual one direction push button switch, one direction magnetic starters, push button stations, power cord.