

138-LRS

Live Roller Spur Conveyor

The Model 138-LRS Live Roller Spur is used in diverging or converging applications. It may be self-powered or can be slave driven from 138-ACC, LRC, or LRSS conveyors.

- 4 Bed Widths
- Reversible
- Right or Left Hand Units Available
- Adjustable LS-Type Floor Supports Available

Conveyor shown with optional floor supports

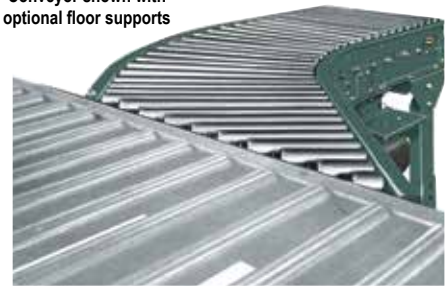

Between Rail Width	Overall Frame Width	"R"	"A"		"B"		"C"		"D"		"E"		"F"	"G"	Number of Rollers*		WEIGHTS (Lbs.)	
			45°	30°	45°	30°	45°	30°	45°	30°	45°	30°			45°	30°	45°	30°
			23"		21"		21"		22 1/2"		41 3/2"				50 23/2"		44 19/2"	
10"	12"		23"	32"	21"	30"											182	190
13"	15"	25"	26"	38"	24"	36"	21"	33"	22 1/2"	41 3/2"	50 23/2"	44 19/2"	9 3/4"	9 5/8"	36S	40S	186	194
16"	18"		32"	44"	30"	42"											190	198
22"	24"	32 1/2"	44"	56"	42"	54"	30"	45"	30 3/4"	55 7/32"	62 3/8"	57 3/32"	10 5/16"	10 1/8"	16S/10T	17S/14T	218	288

*T = TAPERED

S = STRAIGHT

All weights in catalog are conveyor weights only. Accessories, crating, etc., are not included.

NOTE: 24 in. OAW Spur has 1.9 in. dia. tapered & straight rollers mounted in a 6 1/2 in. x 1 in. x 12 ga. painted form steel channel.

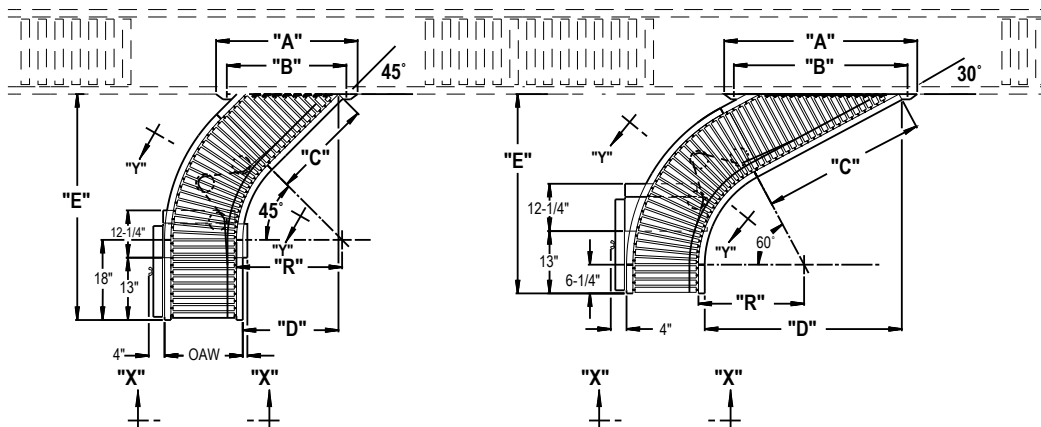
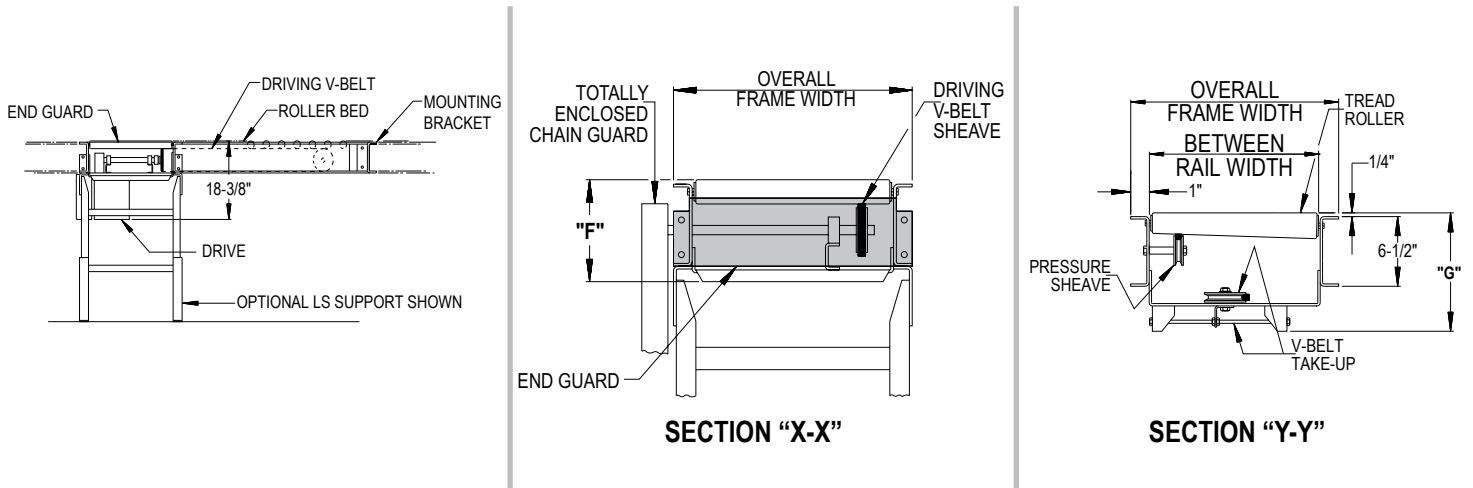

• STANDARD SPECIFICATIONS

BED—Roller bed with 1 3/8 in. dia. roller x 18 ga. galvanized tube and 5/16 in. HRS hex shafts (12 in. thru 18 in. OAW) and 2 1/2 in. dia. tapered to 1 7/16 in. dia. roller x 16 ga. galvanized tube and 1.9 in. dia. straight rollers x 16 ga. galvanized tube 7/16 in. HRS hex shafts (24 in. OAW). Mounted in 6 1/2 in. x 12 ga. powder painted formed steel channel frame.

END DRIVE—Mounted underneath bed section on outside radius.

DRIVING BELT—Endless B-section V-Belt, industrial grade.

PRESSURE SHEAVES—2 1/2 in. dia. with 3/8 in. bore.

IDLER SHEAVE—4 in. dia. x 3/8 in. bore V type and/or 5 1/2 in. dia. x 3/8 in. bore flat type.

TAKE-UP—Take-up provided to maintain proper V-belt tension. Includes 4 3/8 in. dia. x 3/8 in. bore V type take-up sheave.

BEARINGS—Pre-lubricated, self aligning ball bearings in tread rollers. Flange and pillow block bearings are sealed, pre-lubricated with eccentric lock collar.

MOUNTING BRACKET—Bracket is supplied to attach spur to side channels of 138-ACC conveyor.

BUTT COUPLINGS—Standard for connecting 138-ACC and 138-LRS.

SPEED REDUCTION—Sealed worm gear reducer, driven by V-belt. No. 50 roller chain to drive sheave.

MOTOR—1/2 HP—208/230/460/575V—3 PH. 60 Hz. Totally Enclosed.

CONVEYING SPEED—Constant 65 FPM.

CAPACITY—150 lbs. total distributed live load.

FLOOR SUPPORTS—Now supplied as optional equipment.

• SPUR APPLICATIONS

Live Roller Spurs are used to transfer cartons, etc., onto and off of main conveyor lines. The illustrations below shows the correct usage of Plows and Turning Wheels with Spurs in Diverging and Converging applications.

DIVERGING 30° most desirable transfer angle

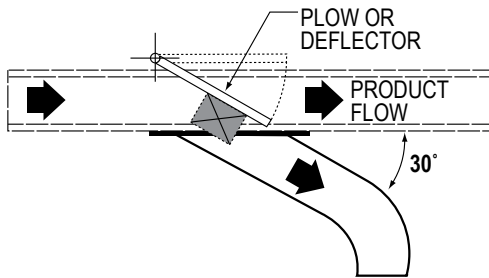

CONVERGING Both 30° and 45° are desirable transfer angles

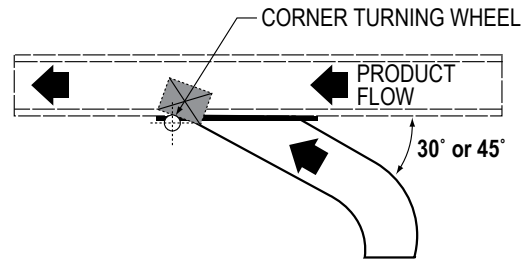

MOUNTING BRACKET

The 138-LRS is equipped with mounting brackets to attach unit to side channel of 138-ACC.

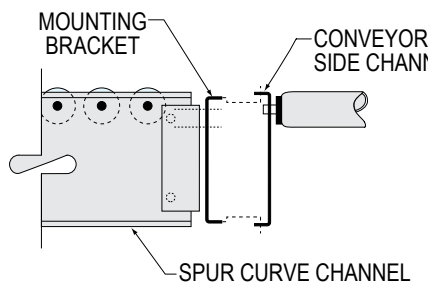

SPUR FLOW (Specify)

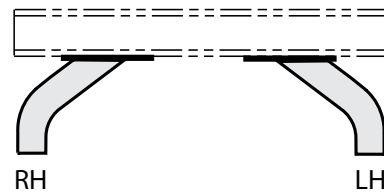

• OPTIONAL EQUIPMENT

FLOOR SUPPORTS—LS Type floor supports are available with a wide range of adjustment. Specify top of belt or roller elevation. One support required at every bed joint and ends of conveyor. Holes in feet for lagging to floor. Knee braces recommended above LS-6 support.

CONVEYING SPEED—Other constant and variable speeds from 25 to 120 FPM. **NOTE:** Capacity affected with speed change.

END DRIVE—Mounted on inside radius. Minimum elevation 18 7/8"

SIDE MOUNTED DRIVE—Motor-reducer unit mounted to side of conveyor. Specify inside or outside. Minimum elevation—11 1/16 in.

O-RING DRIVE CHAIN—With sealed in lubricant (Recommended for applications that do not permit regular lubrication).

GUARD RAILS—Adjustable Universal Channel Guard Rail—Fixed channel—Type A or B angle. See Accessory section. **NOTE:** If product comes in contact with guard rails, product flow will be affected.

POLY-TIER SUPPORTS—36 in. to 120 in. support heights in 6 in. increments. Knee braces supplied.

CEILING HANGERS—3/8 in. dia. x 8 ft. long unplated rods fully threaded. Other lengths and galvanized rods available.

SLAVE DRIVEN—Standard drive may be omitted and curve slave driven from 138-ACC. (Specify by sketch, location of slave connection). Minimum elevation 10 1/2 in.

MOTORS—Energy efficient, single phase, brakemotor, other characteristics. 1/2 HP maximum.

ELECTRICAL CONTROLS—Non-reversing or reversible magnetic starters and push-button stations. AC variable frequency drive.